

CONDOR

Wall Pack

Part No: _____

Notes: _____

Project: _____



Performance Data

CRI 70+ Dimming 0-10v, 10% to 100%
 CCT 4000K, 5000K Operating Temp -40°C to +55°C
 Lifetime L80 100,000+ IP Rating IP 65

Description

The Condor is a medium size highly versatile and durable wall pack in a traditional form factor. The IP65 housing combined with a tempered glass lens provides durable maintenance free lighting for years to come. The Condor offers over 130lpw of energy efficient LED lighting and qualifies for DLC premium rebates to maximize your lighting dollars.

Features

- Highly durable powder coat finish over chromatic conversion coating
- Die cast aluminum IP65 housing UL listed with integral heatsink
- 1/2" threaded conduit entry in 4 convenient locations
- Thermal and shock resistant prismatic glass lens



Ordering Information

Example: TS-GWK05 40 5K U BRZ PM

Series	Wattage	Voltage	Wattage	Lens	Color	Accessories
CD	40 60 100/80/60	H 120-277	4K 4000K 5K 5000K 3K/4K/5K <small>(For Multi Wattage Version)</small>	CL Clear	BZ Bronze BK Black WH White CU Custom	PC Photocell (Included) 10kv 10KV Surge Protector WG Wireguard DSS Dark Sky Shield
				DLC		
				CD 40 4K S-LP9J8A CD 60 4K S-UDRZJW		

DIMENSIONS

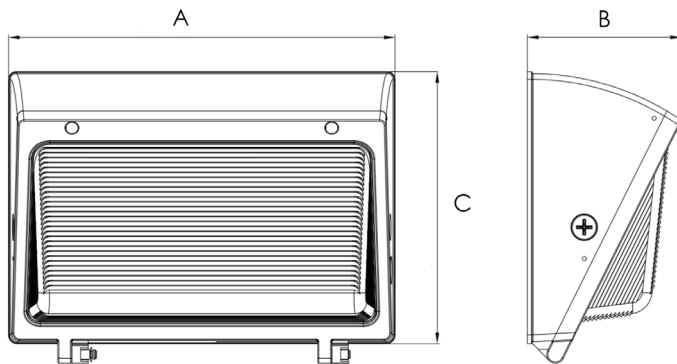

Point	Dimension
A	13.1"
B	5.2"
C	9.2"

LUMEN OUTPUT

Wattage	Watts	Lumens	Efficiency
40W	38	4999	132 LPW
60W	57.8	7599	132 LPW
80W	75.2	9949	132 LPW

LUMEN AMBIENT TEMP MULTIPLIERS

Temperature	Multiple
0c/32f	1.03
10c/50f	1.01
20c/68f	1.00
30c/86f	0.99
40c/106f	0.98

WEIGHT AND PACKAGING SIZE

Wattage	Weight	Box Size LxWxH
40W	5.7 lbs	14.8"x13.2"x9.7"
60W	5.9 lbs	14.8"x13.2"x9.7"
80W	6.0 lbs	14.8"x13.2"x9.7"

ELECTRICAL LOAD CALCULATIONS

Wattage	120V	208V	240V	277V
40W	0.33A	0.19A	0.17A	0.15A
60W	0.50A	0.29A	0.25A	0.22A
80W	0.66A	0.38A	0.33A	0.29A

B-U-G RATING

Wattage	B.U.G.
40W	B3-U3-G3
60W	B3-U3-G3
80W	B3-U3-G3

LUMEN MAINTENANCE

Operating Hours	0	25,000	50,000	100,000
Percent of Initial	100%	96%	93%	86%

ACCESSORIES

INSTALLATION BRACKET WITH LEVEL

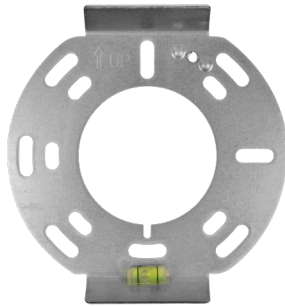

The Condor wall pack features a levelling bracket for accurate installation every time. This standard feature is just another example of how Unite does things better than the competition.

PHOTOCELL



Dusk to dawn photocell comes pre-installed in every Condor wallpack. The photocell will automatically activate the Condor at dusk and shut it off at dawn. If not desired just disconnect the black, white and ground and route power directly to the driver.

WIREGUARD



For harsh and vandal prevalent locations Unite offers an easily field installable wireguard to protect the impact resistant glass lens from breakage. Four pretaped holes are located on each Condor.

DARK SKY SHIELD



The Condor offers an easy to install dark sky compliant shield for high traffic areas. Four conveniently located pretapped holes make installing the shield quick, easy and secure.

PHOTOMETRY

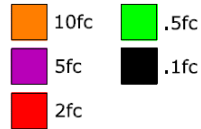

Distance In Increments of 20ft
Mounting Height - 14ft

40W Condor

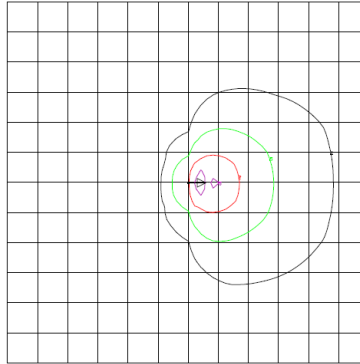
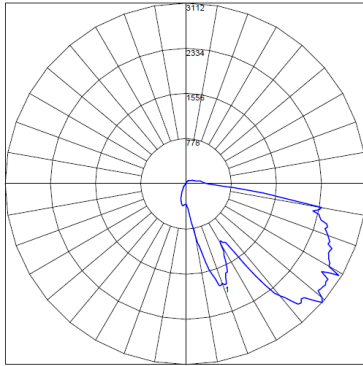

Condor 40W		
Zonal Lumen Summary		
Zone	Lumens	%Fixture
0-30	570	11%
0-40	1012	20%
0-60	2513	50%
60-90	2139	43%
70-100	1367	27%
90-120	268	5%
0-90	4651	93%
90-180	348	7%
0-180	5000	100%

60W Condor

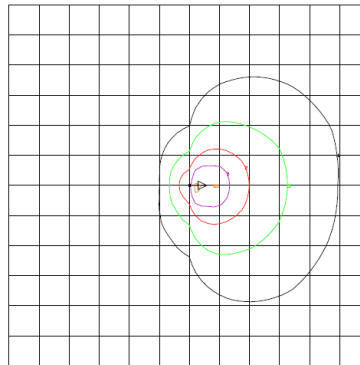
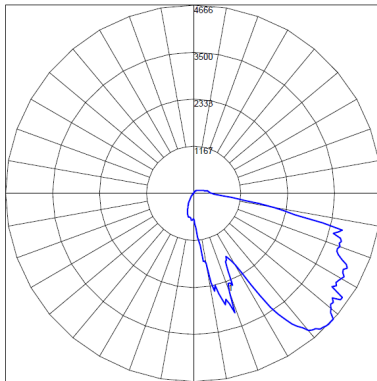

Condor 60W		
Zonal Lumen Summary		
Zone	Lumens	%Fixture
0-30	960	13%
0-40	1747	23%
0-60	178	2%
60-90	2972	39%
70-100	1780	23%
90-120	350	5%
0-90	1750	23%
90-180	448	6%
0-180	7599	100%

80W Condor

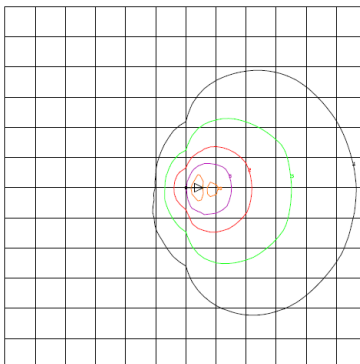
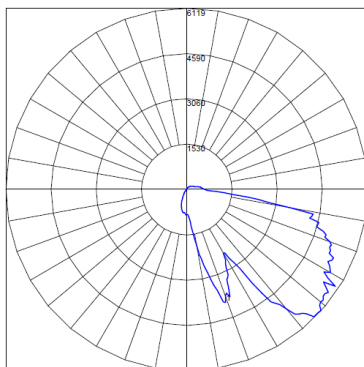

Condor 80W		
Zonal Lumen Summary		
Zone	Lumens	%Fixture
0-30	1198	12%
0-40	2168	22%
0-60	5276	53%
60-90	4045	41%
70-100	2477	25%
90-120	483	5%
0-90	9320	94%
90-180	628	6%
0-180	9949	100%

RENDERS

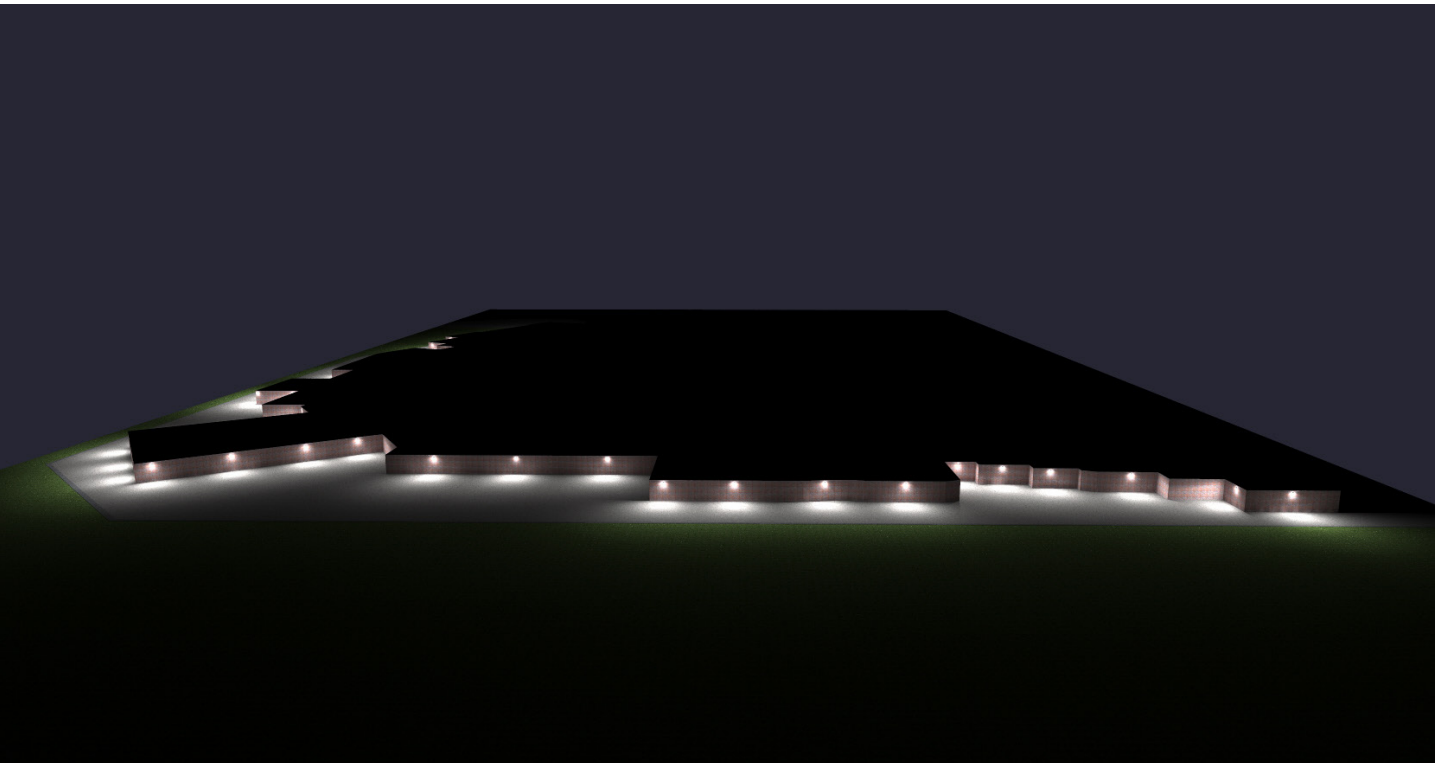
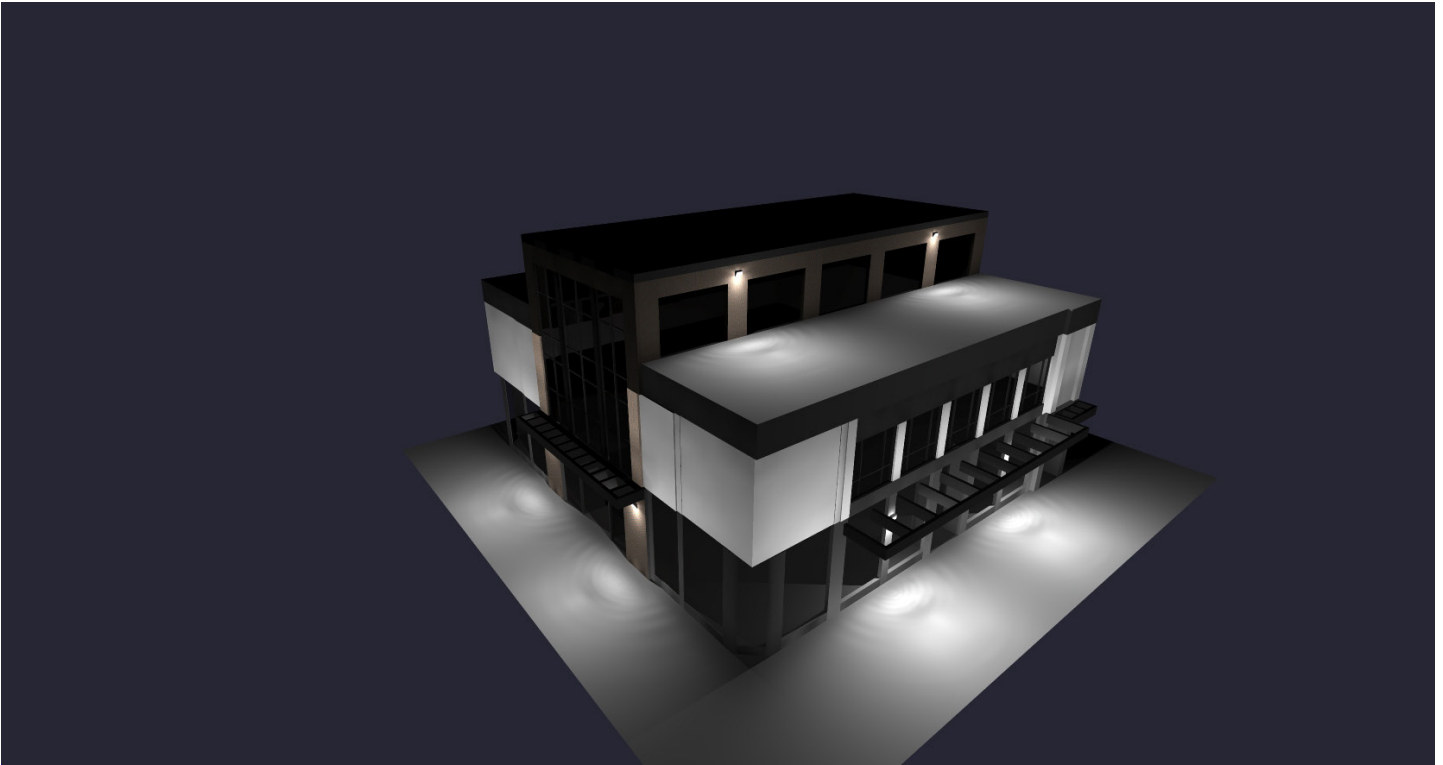

© 2021 Uniteitg